

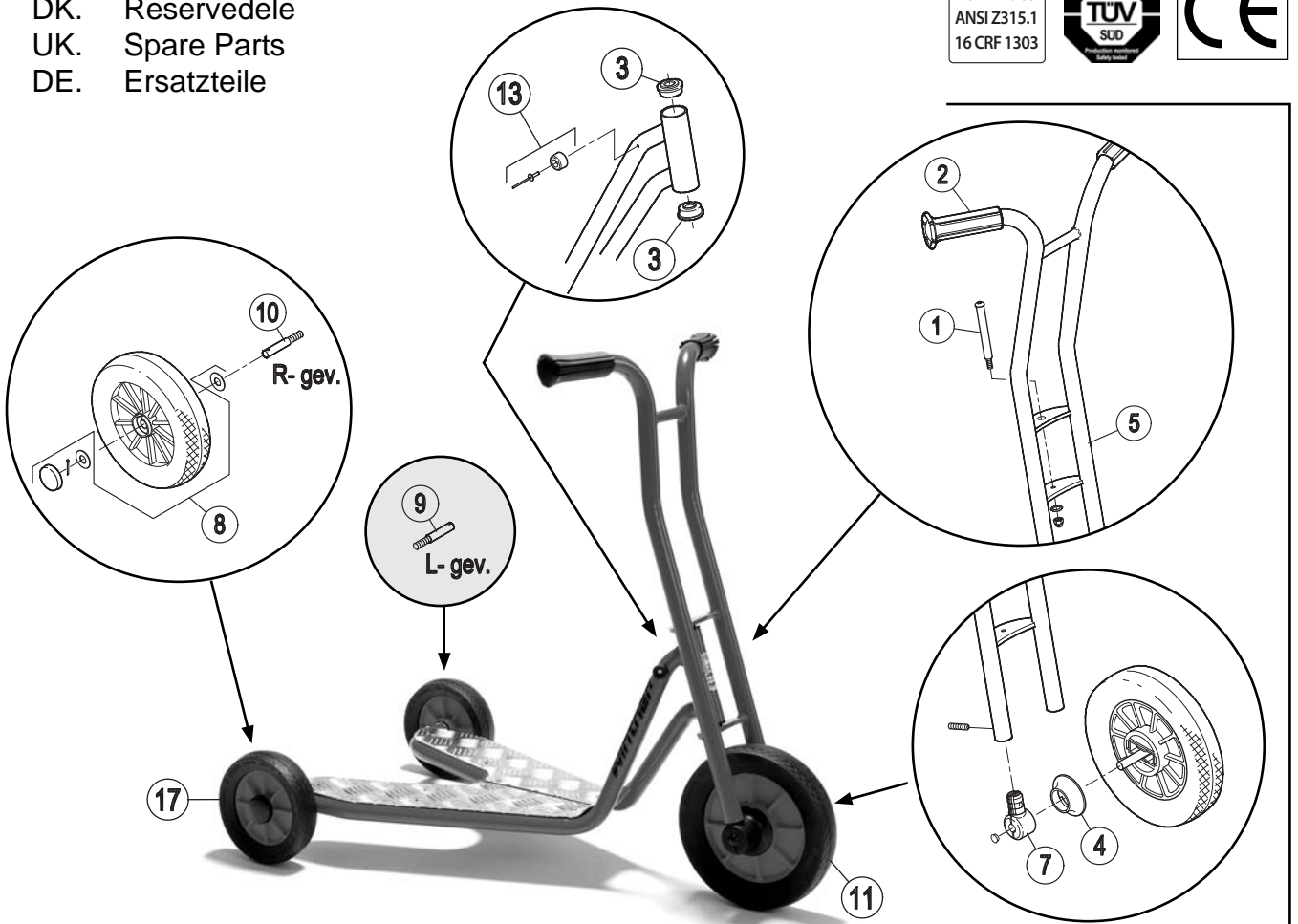

























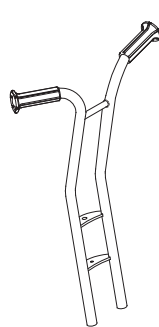

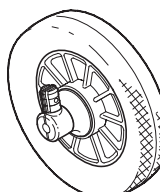

DK. Reservedele
 UK. Spare Parts
 DE. Ersatzteile

ASTM F 963
 ANSI Z315.1
 16 CRF 1303

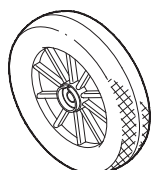
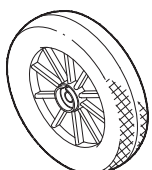

Pos.		Pos.		Pos.	
1	 x1  x2  x1	7	 x2  x2  x2  x1	13	 x2  x2
2	 x2  x2	8	 x4  x2  x2	14	
3	 x2	9	L-gev.  x1	15	
4	 x2	10	R-gev.  x1	16	
5	     	11	  	17	     
6		12		18	

DK. Reservedele
 UK. Spare Parts
 DE. Ersatzteile

ASTM F 963
 ANSI Z315.1
 16 CRF 1303

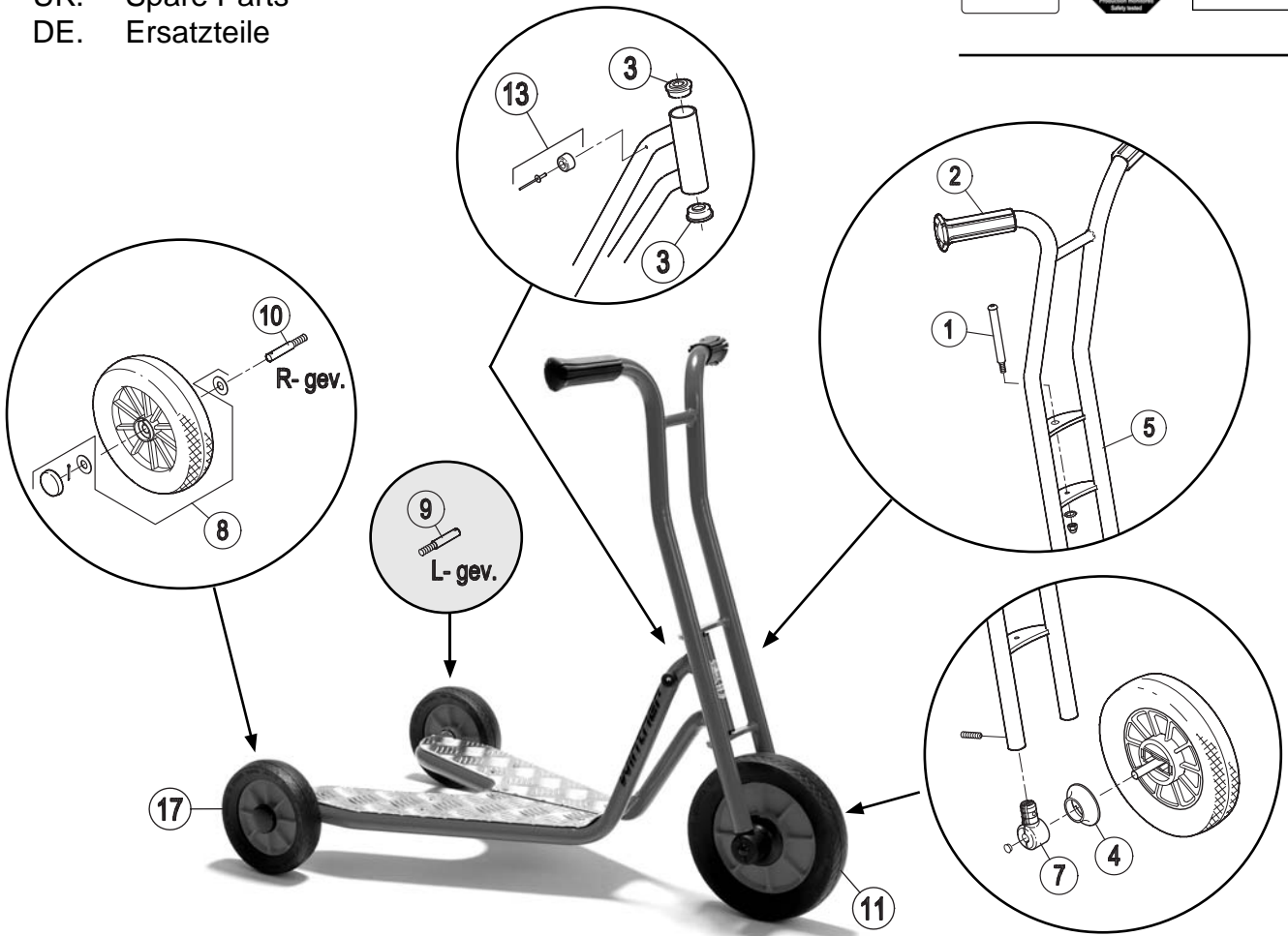

47500									
Version									
Pos.	1.0								
1	50502								
2	50538								
3	50504								
4	50505								
5	50553								
6	-								
7	50508								
8	50520								
9	50526								
10	50525								
11	50563								
12	-								
13	50532								
14	-								
15	-								
16	-								
17	50570								
18	-								