

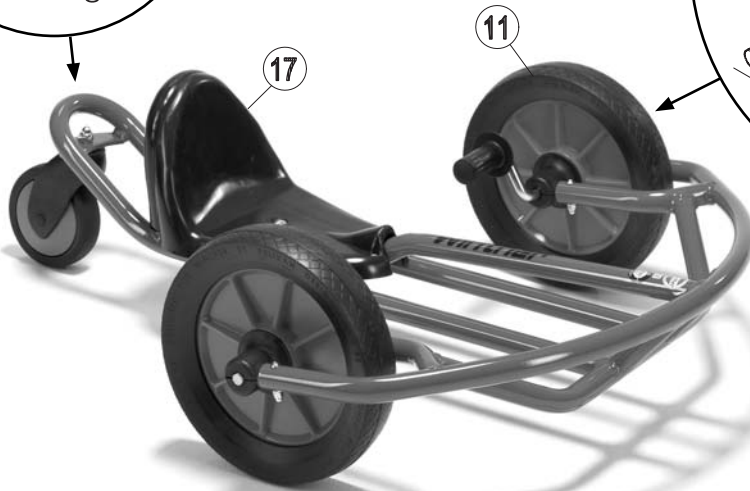

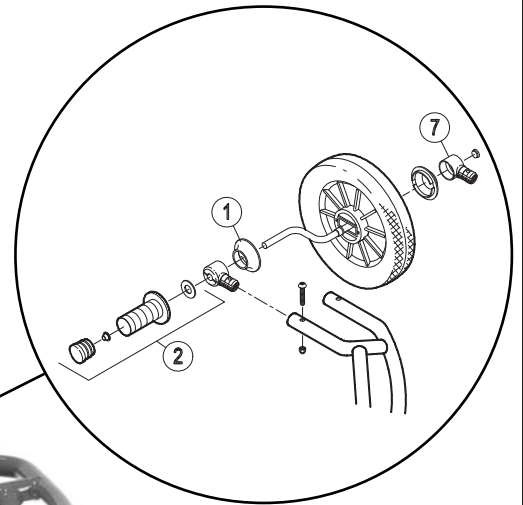

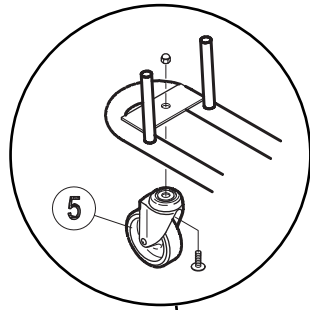













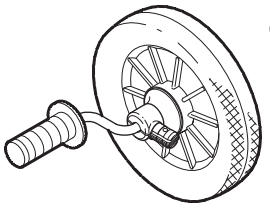

DK. Reservedele
 UK. Spare Parts
 DE. Ersatzteile

ASTM F 963
 ANSI Z315.1
 16 CRF 1303

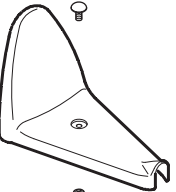

Pos.		Pos.		Pos.	
1	 x2	7	 x2  x2  x2  x2  x1	13	
2	 x2  x2  x2  x2	8		14	
3		9		15	
4		10		16	
5	  	11	    	17	  
6		12		18	

DK. Reservedele
 UK. Spare Parts
 DE. Ersatzteile

ASTM F 963
 ANSI Z315.1
 16 CRF 1303

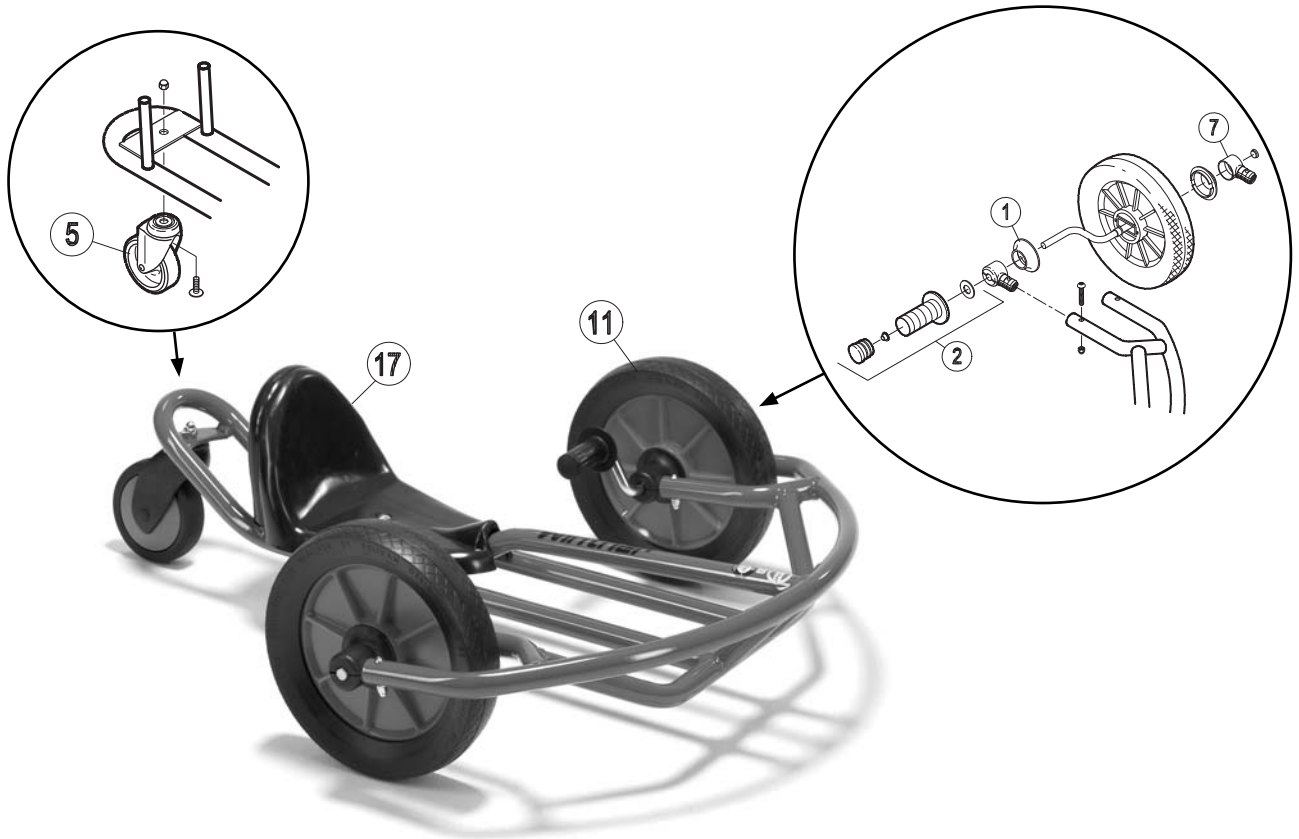

47000									
Version									
Pos.	2.0	3.0							
1	50505	50505							
2	50522	50522							
3	-	-							
4	-	-							
5	50575	50589							
6	-	-							
7	50509	50509							
8	-	-							
9	-	-							
10	-	-							
11	50564	50564							
12	-	-							
13	-	-							
14	-	-							
15	-	-							
16	-	-							
17	50581	50581							
18	-	-							