

# 556.50



EN 71

ASTM  
F963



- DK** Reservedele
- GB** Spare Parts
- DE** Ersatzteile

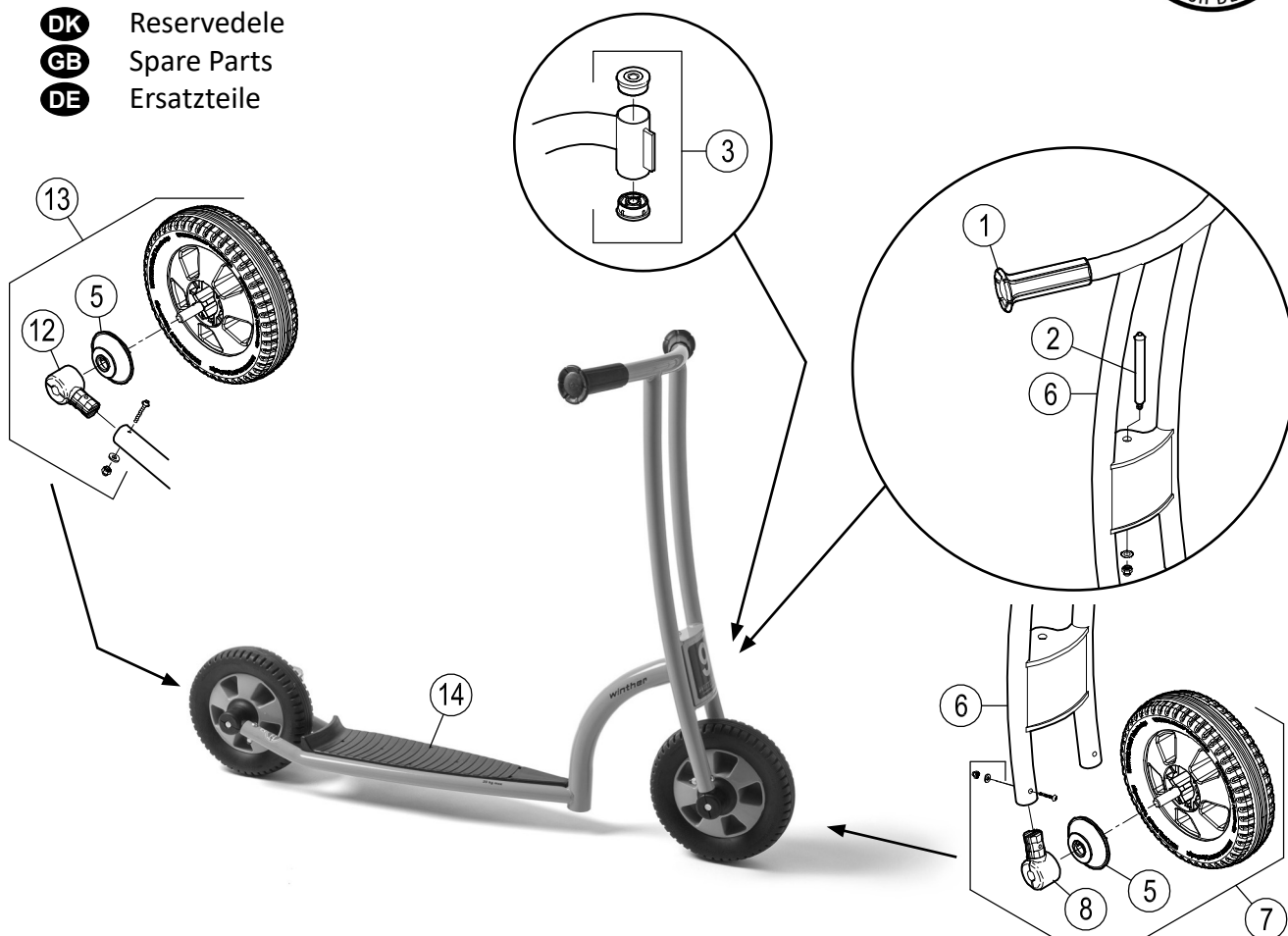

Pos.		Pos.	
1	x2    x2	8	x2    x2    x1
2	x1    x2    x1    x1    x1	9	
3	x2	10	
4		11	
5	x2	12	x2    x2    x2    x2    x1
6		13	
7		14	

# 556.50



EN 71

ASTM  
F963



- DK** Reservedele
- GB** Spare Parts
- DE** Ersatzteile

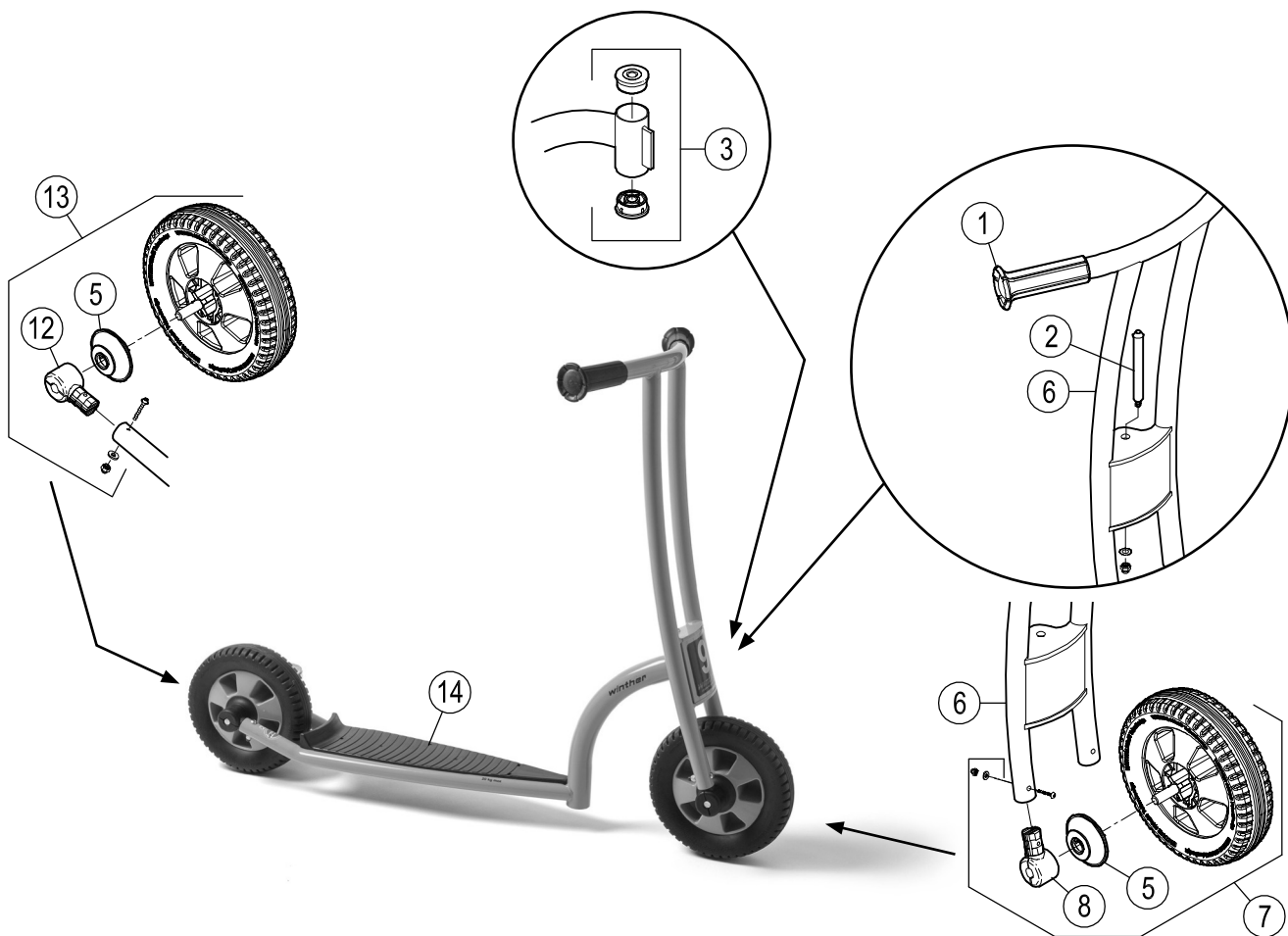

556.50					
Version					
Pos.	1.0				
1	50403				
2	50401				
3	50404				
4	-				
5	50270				
6	50454				
7	50280				
8	50406				
9	-				
10	-				
11	-				
12	50407				
13	50288				
14	50486				
15	-				

